

TABLE-GAUGE.X



Use the Xactum Intelligent Laser Gauges as bench-top micrometers, in the Table-Gauge configuration:

with no other instrument can you measure diameters so quickly, so accurately and so easily.

It's the ideal instrument to check pins, ground or other turned parts.

No matter what the operators' skill level!

Ultra-accurate and perfectly reproducible measurements thanks to Aeroel's outstanding Laser Technology offered at affordable conditions.

The Table-Gauge.X

The XLS gauges are programmed with a dedicated software and are completed with a display unit, a remote control, fixturing to hold the part and a base-plate for bench-top use: using this "Table-Gauge" assembly you can, in a few seconds, check the diameter, roundness and the concentricity of ground or turned parts, to an accuracy that before only could be obtained in a metrology room, by using much more expensive equipment and specialized personnel.



System Configuration

The Table Gauge X system is composed by:

- a single axis Xactum gauge, XLS40 or XLS80 type
- Table-Gauge.X software pre loaded in the gauge
- DM-100 multi-color LED display
- universal power supply
- I.R. Remote Control
- bracket to hold the display
- base plate for the gauge

Some optional accessories are available

- V blocks to hold the part
- linear slide and the gauge-base to translate the part
- fixed V blocks to be mounted on the slide
- centers and cones to hold the part
- foot switch
- Hand-held programming terminal
- GageXcom software for PC communication

Types of measurements

It measures the diameter **D** and the position **C** of the Center of the part, from the Center of the measuring field. The part can be **opaque or transparent**.

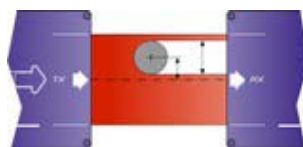

The measuring time (or the measuring frequency) can be set by programming the number of scans being averaged, to get the required repeatability and resolution. ⁽¹⁾



Exclusive Aeroel features



- The scanning motor based on the **Fluid Dynamic Bearing technology**, without ball bearing works perfectly, with no wear.
- **The NO-VAR option** allows you to automatically compensate for the expansion of the part when room temperature changes. The user only needs to program the proper coefficient of thermal expansion of the part.
- **The Web Server** allows you to connect the sensor through the Ethernet line to any Internet browser and "see it" as a website, where you can view the measures, set-up and program the gauge and even display the video signal (light pulse).

Measuring modes

Free-running diameter measurement: put the part on the fixture and you will get the continuous reading of the diameter on the display.



Selecting the **Auto-sync mode**, you will get one measurement only, triggered just after having positioned the part and after a programmable delay. The display will hold the measurement after you have removed the part.

On-command measurement: you will get the Average, Maximum and Minimum readings and the Range Values = Max-Min. The Start/Stop command can be remote (Ethernet/RS232) or local by using the remote control the display SET key or a digital input line. By connecting a foot switch you can have the hands free to handle the part.



Single face scanning: in all measurement modes, you can use 1 mirror face only, to cancel the side dither of the scanning plane: when this option is selected, the scanning rate is reduced to 125 Hz.

Measurement examples

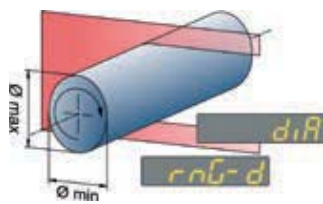

Diameter and roundness: rotate the part by 180° and measure the diameter, display the average diameter and the value of the Diameter Range = Dmax-Dmin.

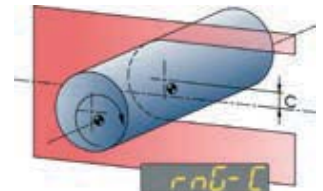

Run-out: measure of the center position during a 180° rotation, with the part held between centers, and display the value of the Center Position Range =

Cmax-Cmin. You will get the run out of the measured section referred to the center axis.

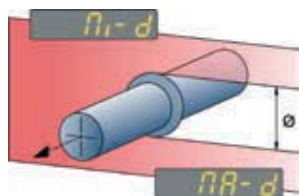

Sphere or Groove diameter: move the part along its axis and measure the diameter, display the Maximum or Minimum Diameter value.

Display and remote control



Multicolor LED display to show the measured values and to allow system programming through the IR remote control.

The measured and programmed data can be scrolled on the display by using the remote control or

the SET key on the display panel.

It is possible to save in memory, in a **Product Library**, up to 1000 different sets of programmed parameters, for each specific part to be checked.

The display color will change corresponding to the tolerance



status of the shown variable (**green, orange or red**).

The display unit includes **4 programmable alarm output lines** to drive additional external devices.



Simple and quick **programming using the remote control** keys and the messages on the display.

Offset function for user re-mastering.

Selectable Measuring Units inch/mm and Resolution (to 0.01µm / 1x10-6 inch).⁽²⁾

PC interface

An **external/remote computer** can be connected to the system through the **Ethernet/RS232** interface, to **program the system or to get the measured data**.

The **Web Server** allows you to connect the sensor through the Ethernet line to any Internet browser and "see it" as a website



It is possible to use the RS232 port in VT100 emulation mode, which makes it possible the connection of the system to a PC using the **Windows⁽⁴⁾ Hyperterminal** program or to a hand-held programming terminal.



Using the optional **GageXcom software** provided by Aeroel, you can use **Excel⁽³⁾** spread-sheets to set-up the system and to get all measured results:

you can write your own applications by writing suitable Excel Macros and using standard Excel functions to process data.

(1) The minimum averaging scan number is preset to 12; the maximum measuring frequency is 125 Hz. The measuring repeatability can be computed by dividing the single shot repeatability (see the gauge data sheet) by the square root of the averaging scan number.

(2) Due to the display limitations, the 6 most significant digits only are shown; the full resolution is anyway available using the serial output ports.

(3) Windows and Excel are registered trademarks of Microsoft Corporation

Technical characteristics

BASIC SYSTEM

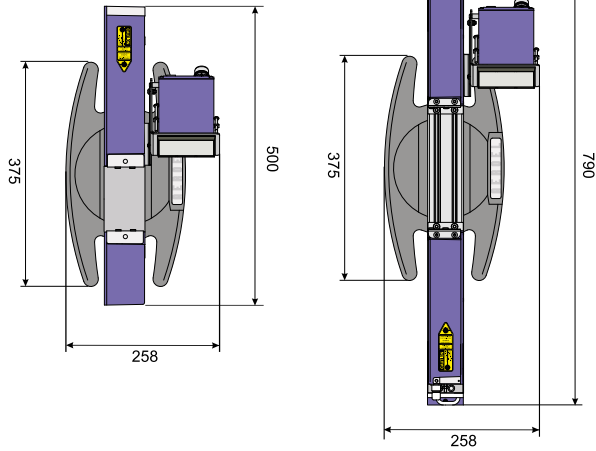

OPTIONAL BASE AND SLIDE

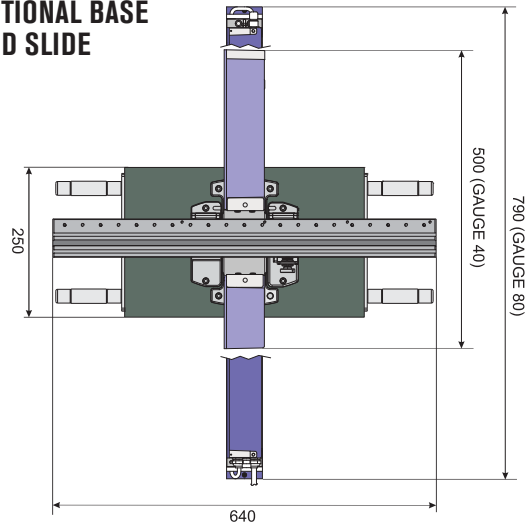

All dimensions are in mm. For additional details and complete specifications please see the gauge data sheet.



DISPLAY AND ALARMS MODULE DM-100

- Main Display LED** 6 digits, 7 segments multicolour
- Sub Display LED** 2 digit
- 6 Warning lights** for the Status of the Inputs and the Outputs
- 4 Outputs** protected PNP, I_{max}: 100 mA
- 2 Inputs** PNP, I_{typ.}: 15 mA
- Dimensions:** 97 x 49 x 158 mm
- Weight:** 0.5 kg
- Power supply:** 24 VDC 150 mA

I.R. REMOTE CONTROL

- Size:** 180 x 50 x 26 mm
- Weight:** 80 g (without batteries)
- Power supply:** 2 AAA 1.5 V batteries

Available models

	TABLE-GAUGE.X40	TABLE-GAUGE.X80
Gauge Model	XLS40	XLS80
Beam height (mm)	40	80
Measurement range (mm)	From 0.06 to 38	From 0.75 to 78
Scanning rate (Hz)	1500	
Resolution (µm)	0.01 at best	
Repeatability (µm)	± 0.07 at best	± 0.2 at best
Linearity (µm)	± 0.5 at best	± 1 at best

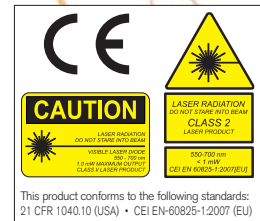

Specifications subject to change without notice. For additional details and complete specifications please see the gauge data sheet.

AEROEL AEROEL S.R.L.
 Via Pier Paolo Pasolini 35/3
 Pradamano (UD)
 33040 - ITALY
 Phone +39 0432 671301
 Fax +39 0432 671543
 e-mail: aeroel@aeroel.it
 http: //www.aeroel.it

